

**GENERAL NOTES:**

1. Frame fabricated with .75" x .1875" flat bar
2. Design fabricated with .75" x .125" flat bar
3. Mounting holes .28" dia (7mm)

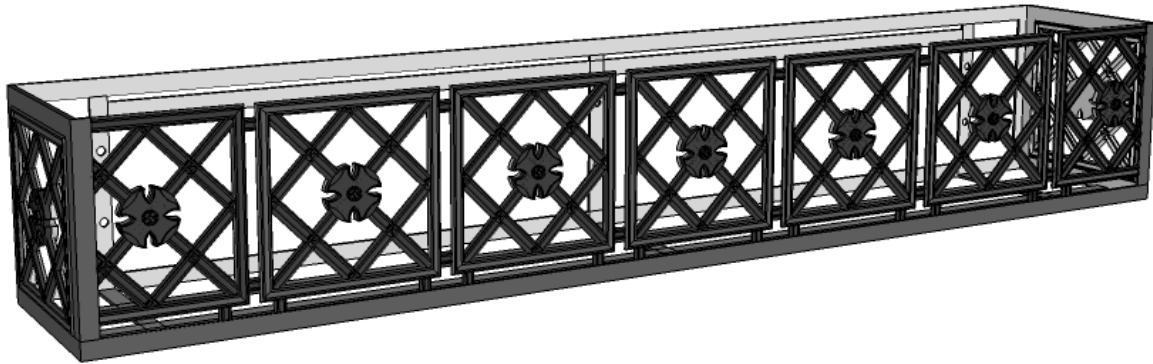

PERSPECTIVE VIEW

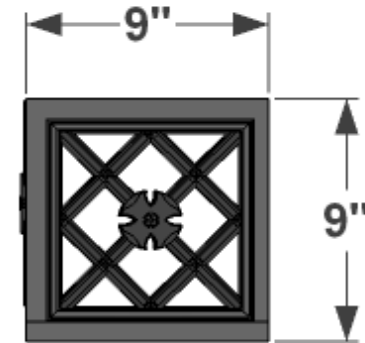

SIDE VIEW

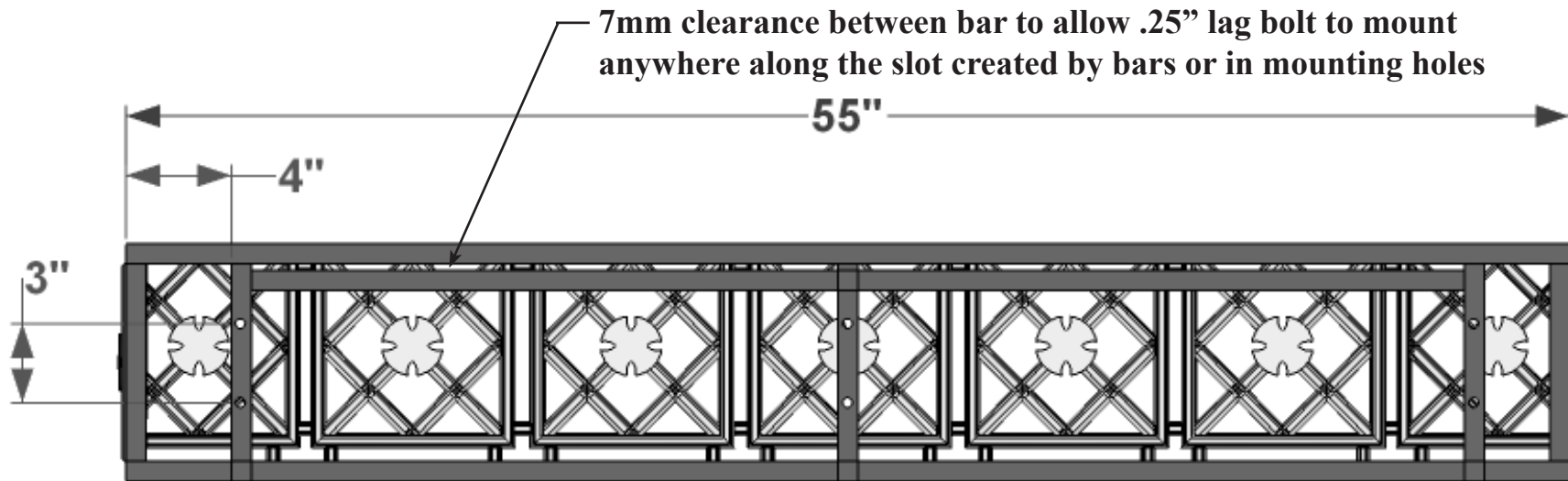

BACK VIEW

7mm clearance between bar to allow .25" lag bolt to mount anywhere along the slot created by bars or in mounting holes

Date:  
Scale: NTS  
DB: GGG  
CB:  
Rep:  
Order#:

Content: Alexandria Aluminum Window Box  
PN: CM-703-54  
Color/Finish: Black Powder Coat  
Customer Approval: \_\_\_\_\_

Design by Hooks and Lattice. All visual representations and designs are the intellectual property of Hooks and Lattice and protected under copyright law. Any duplication of this design is in direct violation of the law and will result in legal action. © Copyright 2008-2015

**Hooks & Lattice**  
A GARDEN MARKET  
T:800-896-0978 F:760-603-0862