

Detail Perspective

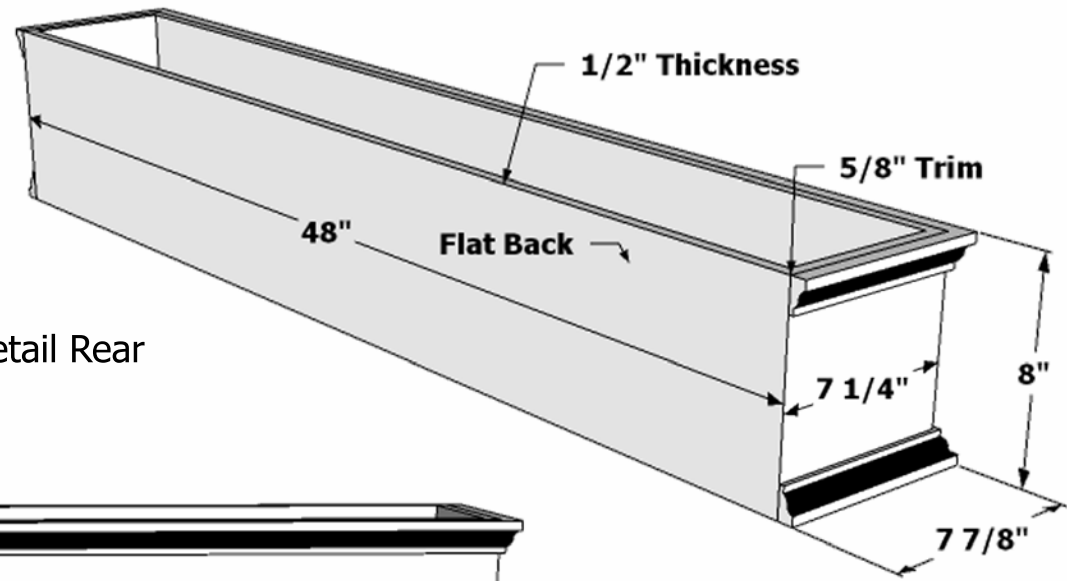

Detail Rear

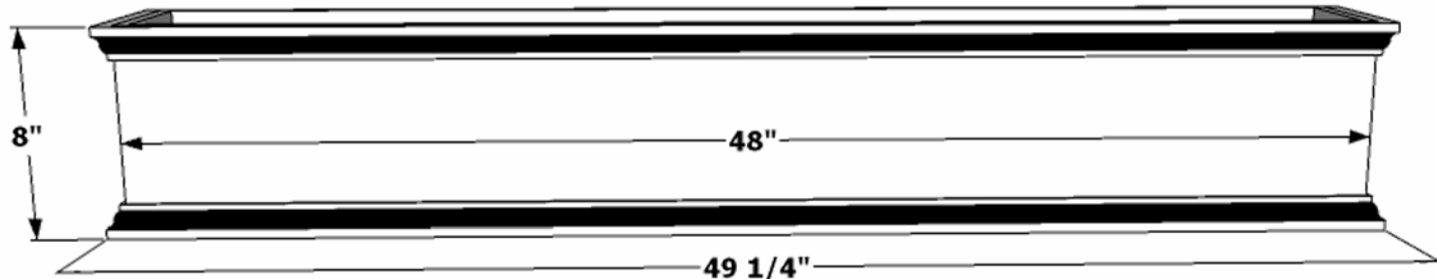

Detail Front

Date: April 2011
 Revision:
 Sheet: A
 PN# A2-015-48

Drawn by: KE
 Content: Direct Mount Laguna Premier Flower Box 48"

Design by Hooks and Lattice
 All visual representations and designs are the intellectual property of Hooks and Lattice and protected under copy-right law. Any duplication of this design or any element is in direct violation of the law and will result in legal action.

© Copyrighted 2008-2010

Customer Approval: _____

Hooks & Lattice
 A GARDEN (HL) MARKET
www.hooksandlattice.com
 1-800-896-0978 1-760-603-0888