

Detail Perspective

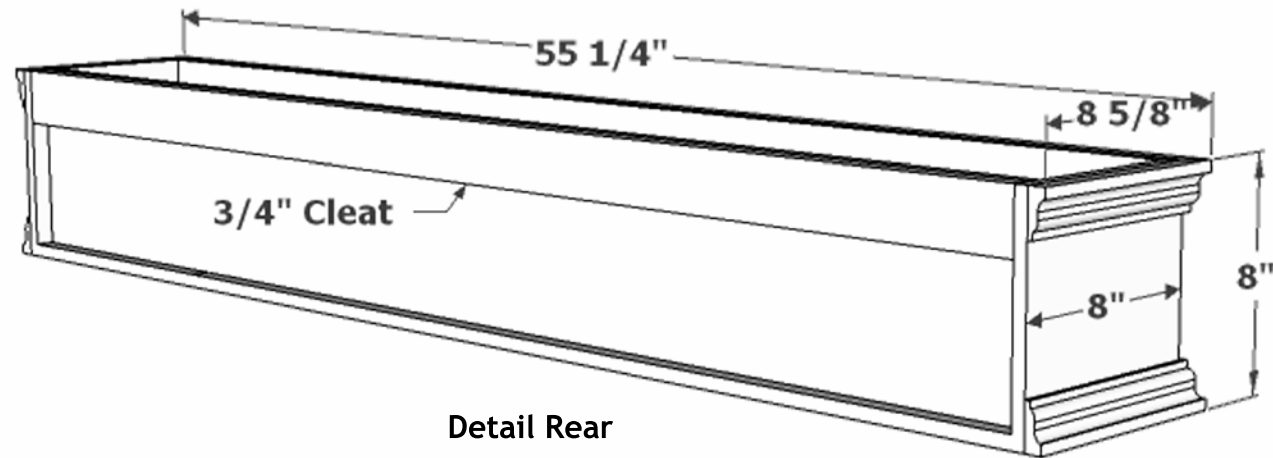

Detail Rear

Windowbox to have 3/8" Drainage Holes Standard

Material is 5/8" Thick Premier Composite PVC

Date: Feb 2011  
 Revision:  
 Sheet: A  
 PN# A2-100-54

Drawn by: KE  
 Content: Standard Laguna Premier Window Box with Cleat  
 54"L x 8"W x 8" H

Design by Hooks and Lattice  
 All visual representations and designs are the intellectual property of Hooks and Lattice and protected under copy-right law. Any duplication of this design or any element is in direct violation of the law and will result in legal action.

© Copyrighted 2008-2010

Customer Approval: \_\_\_\_\_

**Hooks & Lattice**  
 A GARDEN HL MARKET  
[www.hooksandlattice.com](http://www.hooksandlattice.com)  
 1-800-896-0978 1-760-603-0888