

Detail Perspective

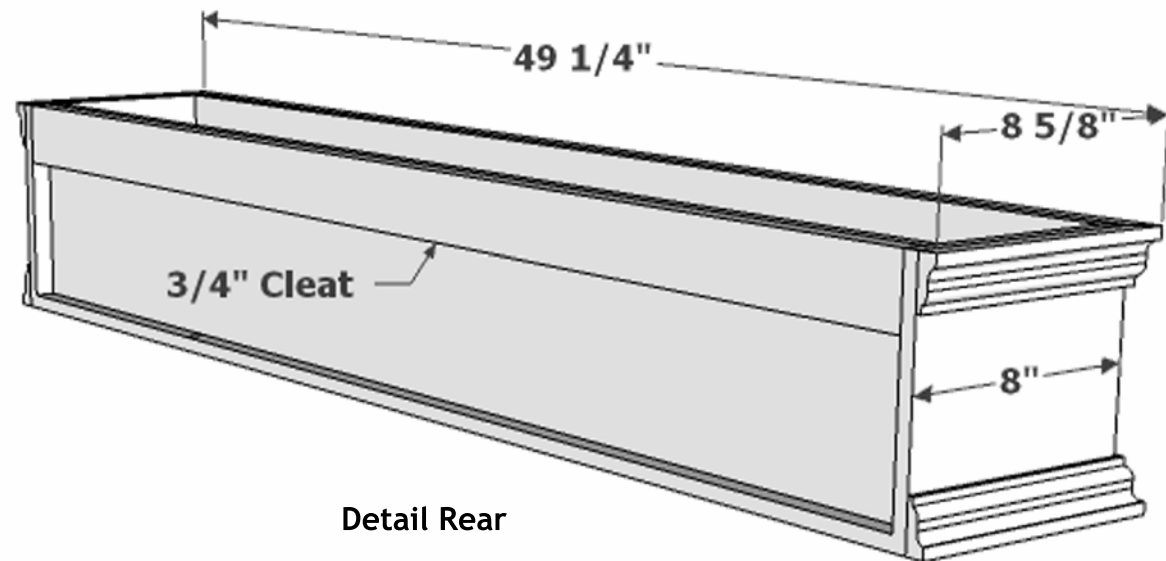

Detail Rear

Windowbox to have 3/8" Drainage Holes Standard

Material is 5/8" Thick Premier Composite PVC

Date: Feb 2011
 Revision:
 Sheet: A
 PN# A2-100-48

Drawn by: KE
 Content: Standard Laguna Premier Window Box with Cleat
 48"L x 8"W x 8" H

Design by Hooks and Lattice
 All visual representations and designs are the intellectual property of Hooks and Lattice and protected under copy-right law. Any duplication of this design or any element is in direct violation of the law and will result in legal action.

© Copyrighted 2008-2010

Customer Approval: _____

Hooks & Lattice
 A GARDEN HL MARKET
www.hooksandlattice.com
 1-800-896-0978 1-760-603-0888