

General Notes:

- 1. Frame, Back and Bottom Supports: 3/4"W x 1/8" Thk Flat Bar
- 2. Design: 3/4"W x 1/8" Thk Flat Bar
- 3. Mounting Holes:  $\phi$  1/4"
- 4. 7mm clearance between back bars to allow  $\phi$  1/4" lag bolt to mount anywhere along slot.

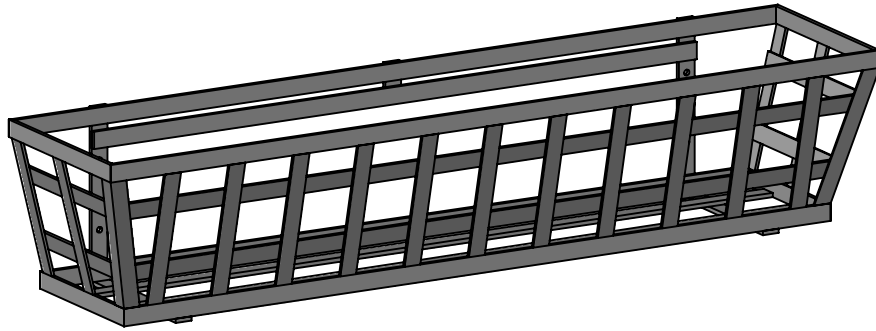

PERSPECTIVE VIEW

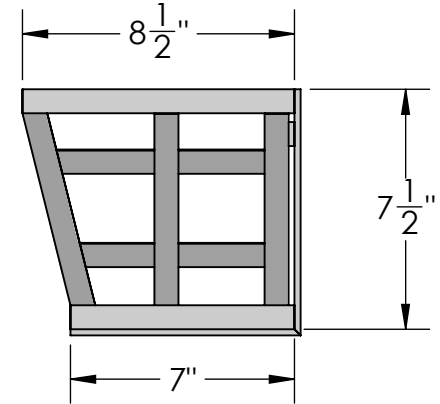

SIDE VIEW

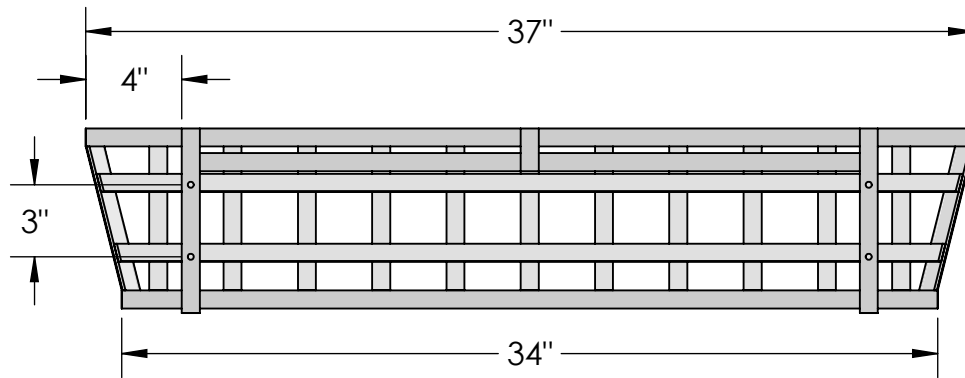

BACK VIEW

Date:  
 Scale: NTS  
 DB: ZB  
 CB:  
 Rep:  
 Order #:

Content: Santiago Decora Window Box

PN: 515B-36

Color/Finish:

Customer Approval: \_\_\_\_\_

Design by Hooks and Lattice. All visual representations and designs are the intellectual property of Hooks and Lattice and protected under copyright law. Any duplication of this design is in direct violation of the law and will result in legal action.

© Copyright 2008-2017



**HOOKS & LATTICE**  
 T: 800-896-0978 F: 760-603-0862